

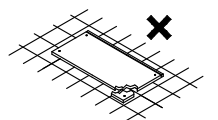

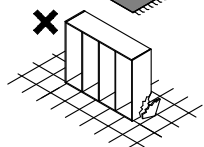

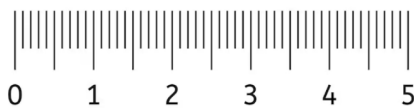

LEXI R-15

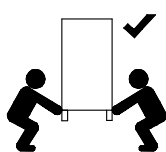
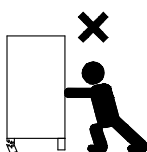
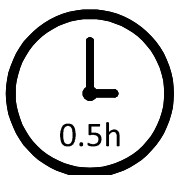
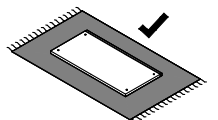
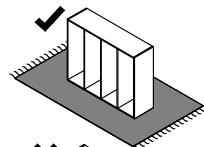
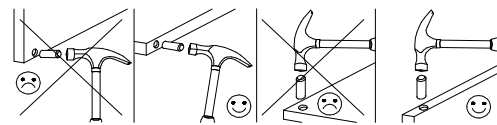
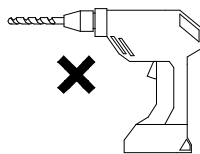
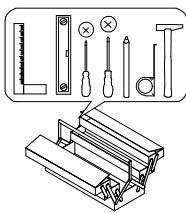
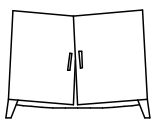
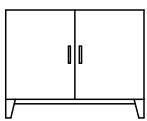
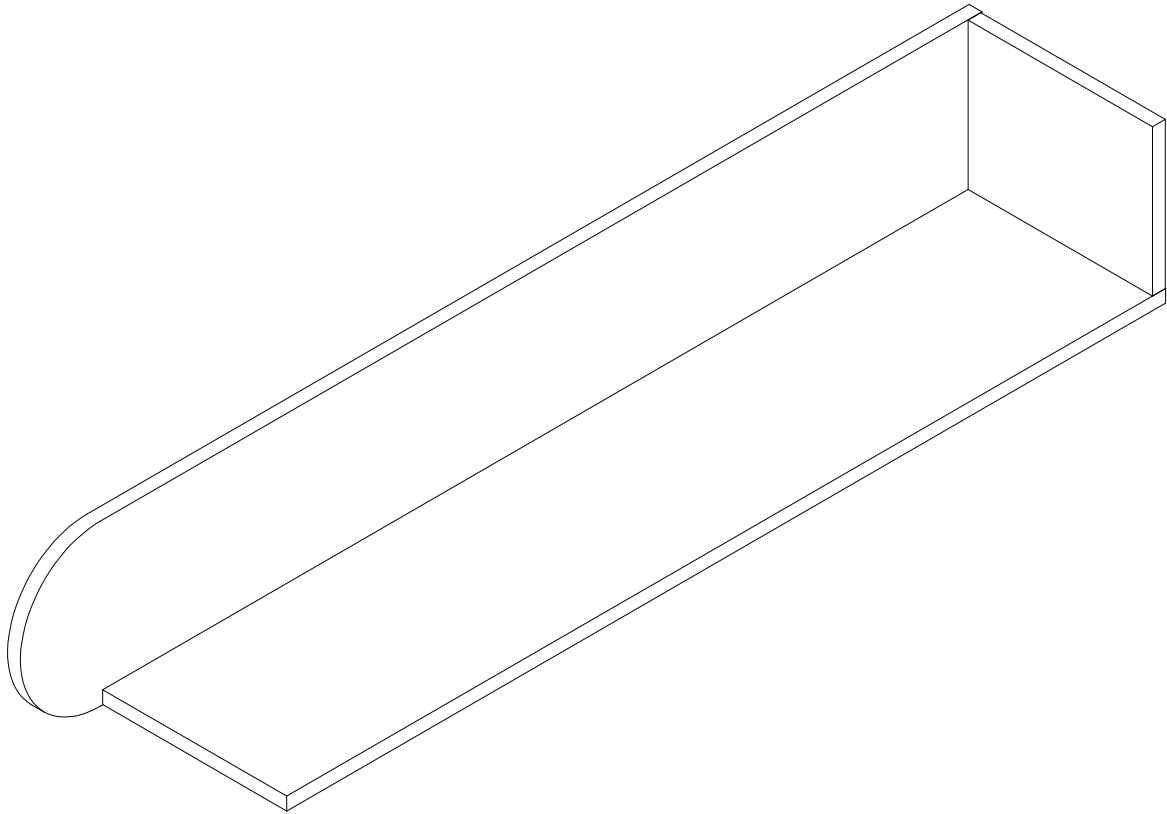
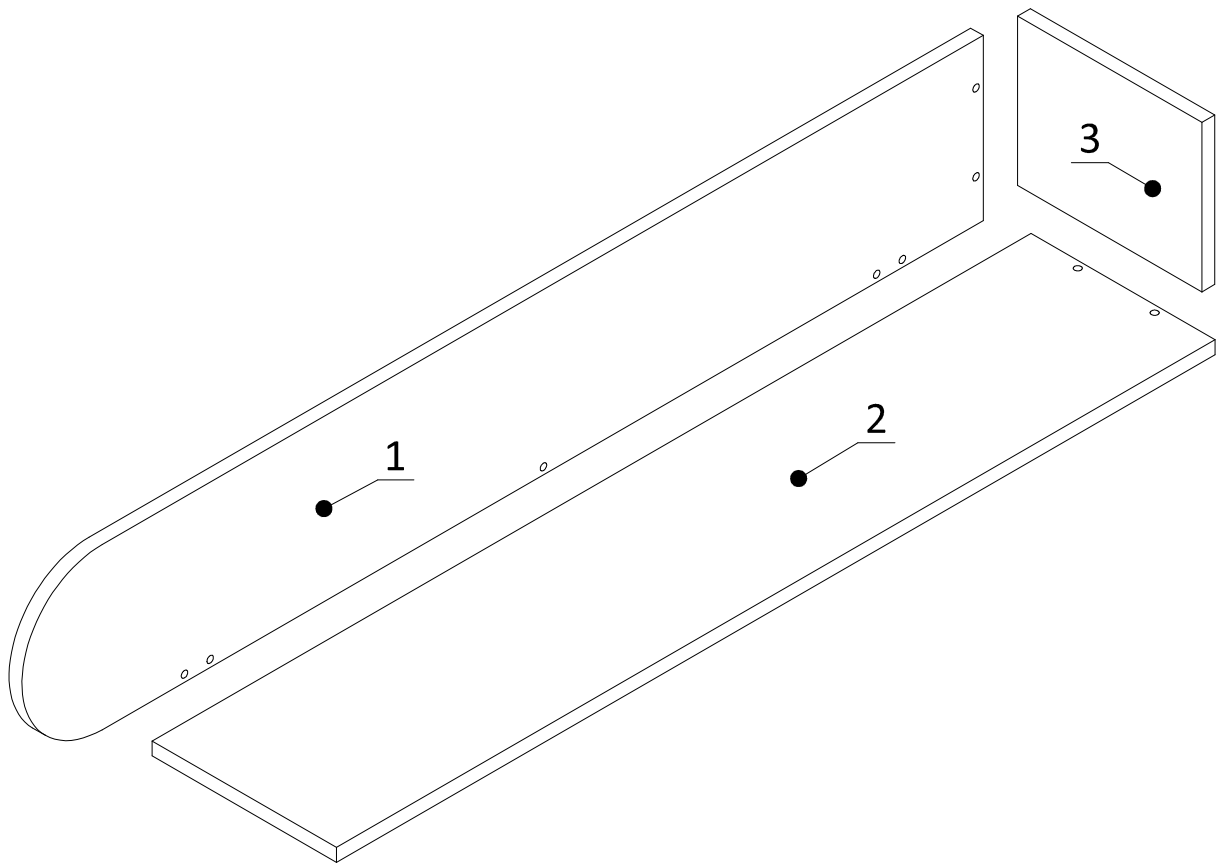
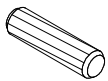
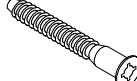



 8x30	 7x50	 SW4	 ZK	 ZW	 6,3x9
K	KF	KL	ZK	ZW	E2
2x	7x	1x	2x	2x	4x

1

	
ZW	E2
2x	4x

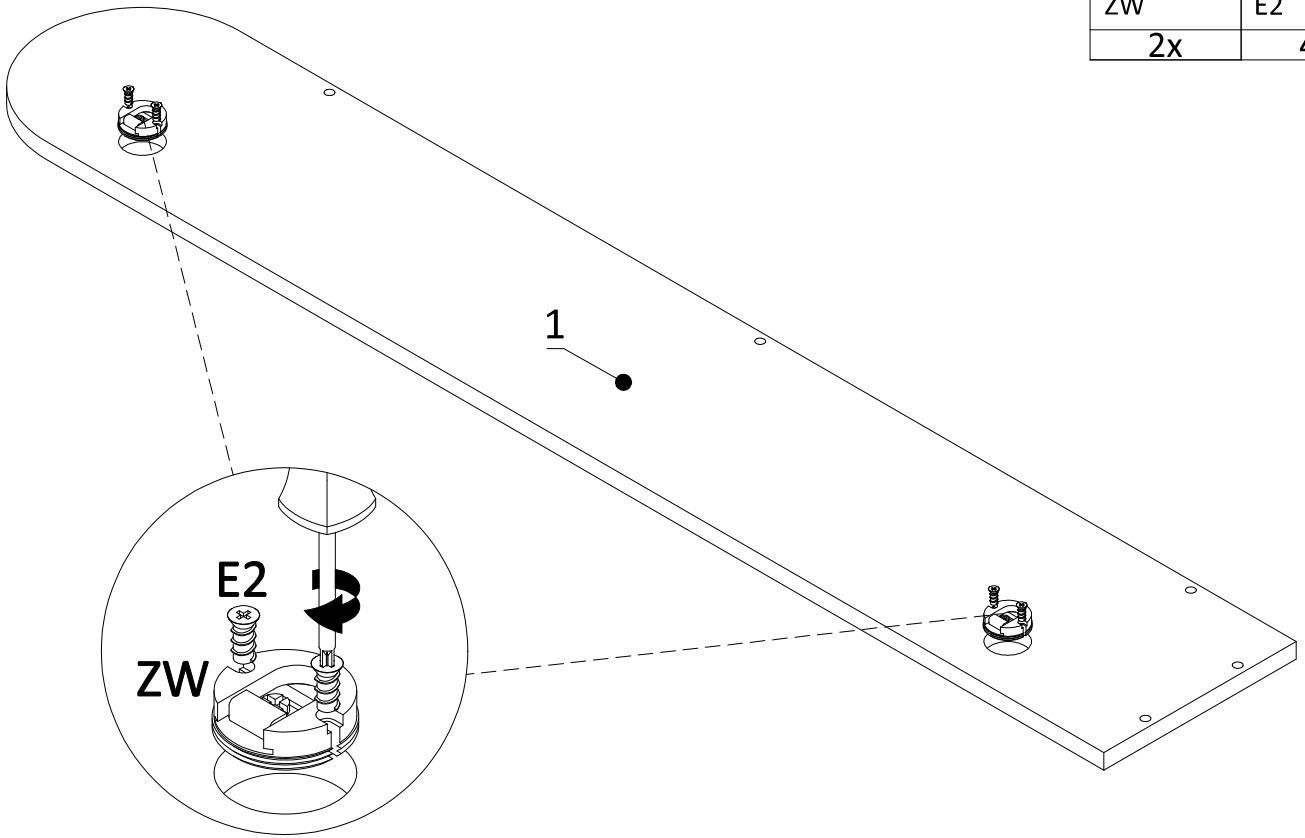

2

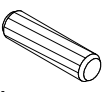

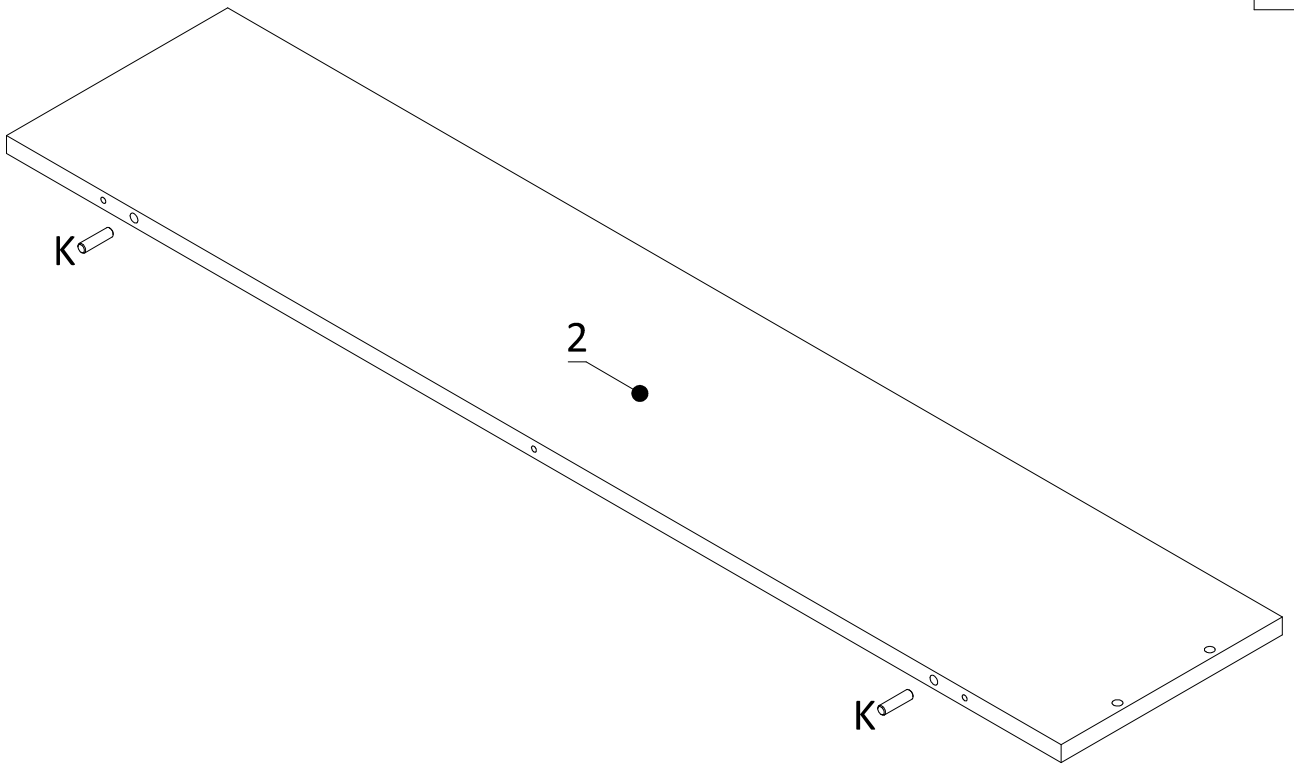
K
2x

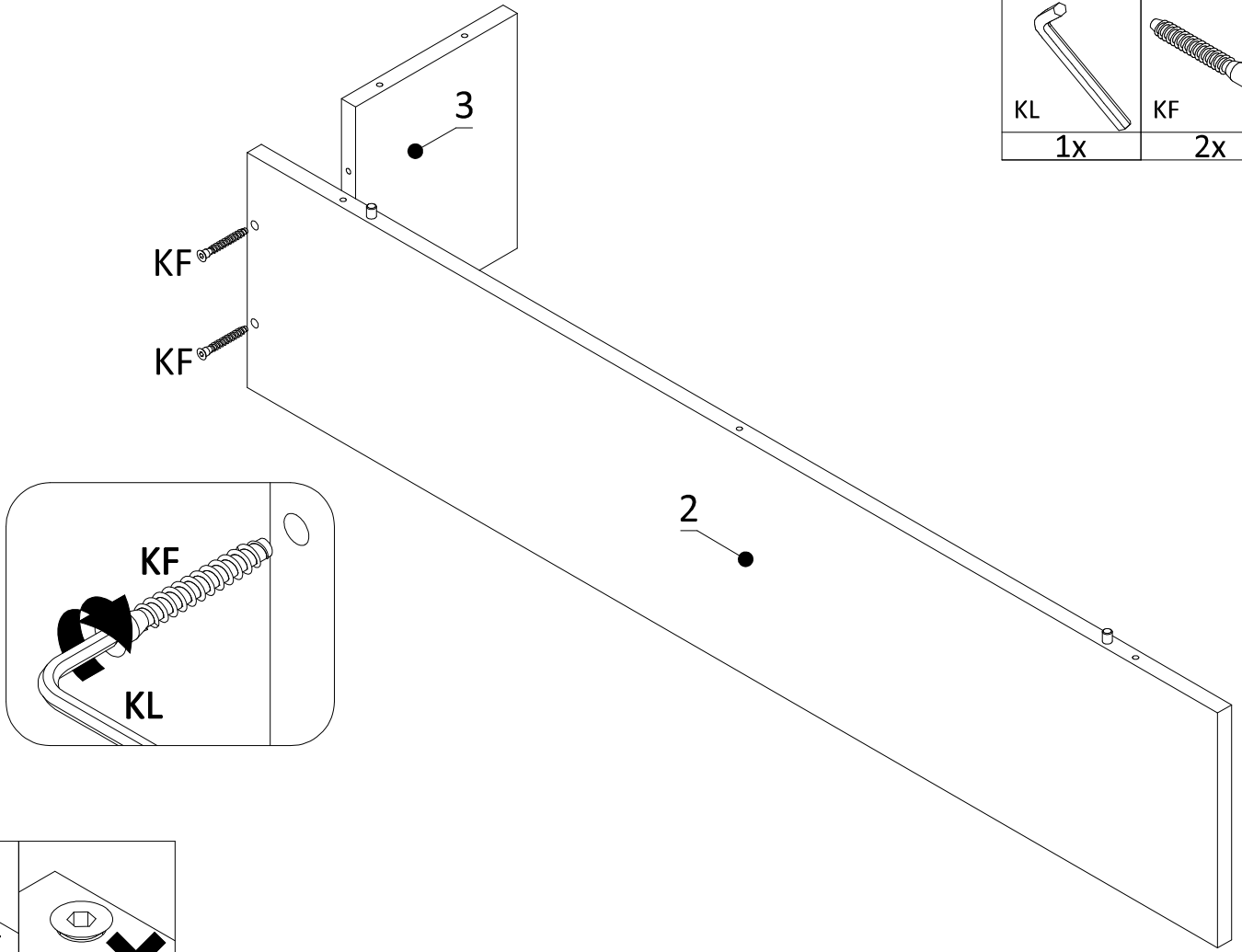

3

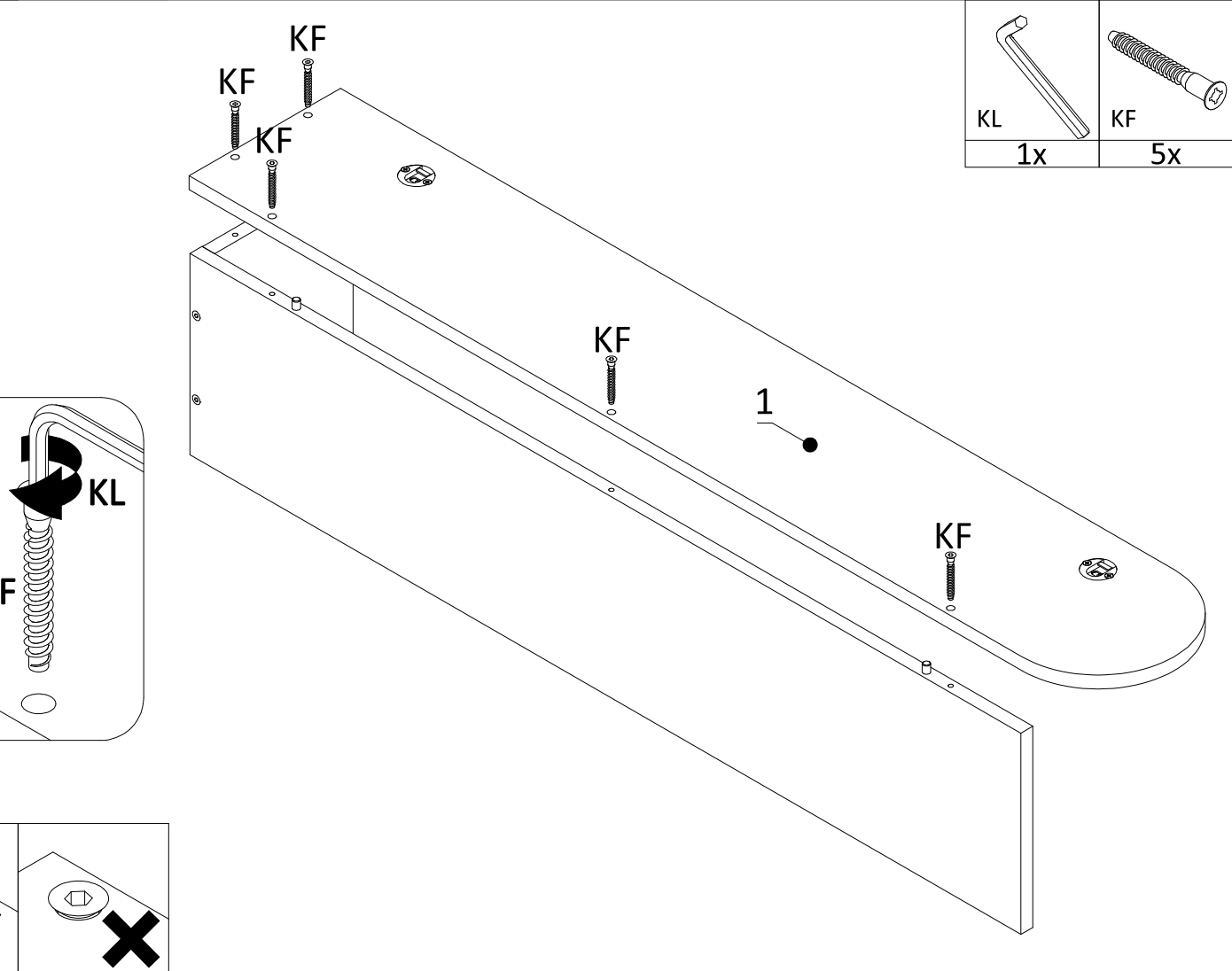

4



5

